

Gábor Dénes-díjasok Klubja, Klubest, 2018. február 16.

# A műholdas kvantumkommunikáció hajnala

Bacsárdi László

Soproni Egyetem, Simonyi Károly Kar, Informatikai és Gazdasági Intézet  
intézetigazgató, egyetemi docens

BME Mobil Kommunikáció és Kvantumtechnológiák Laboratórium  
tudományos munkartás

Kép forrása: ESA

# KVANTUMBIT

$$|\varphi\rangle = a|0\rangle + b|1\rangle$$

$$|a|^2 + |b|^2 = 1 \quad a, b \in \mathbb{C}$$

QUBIT

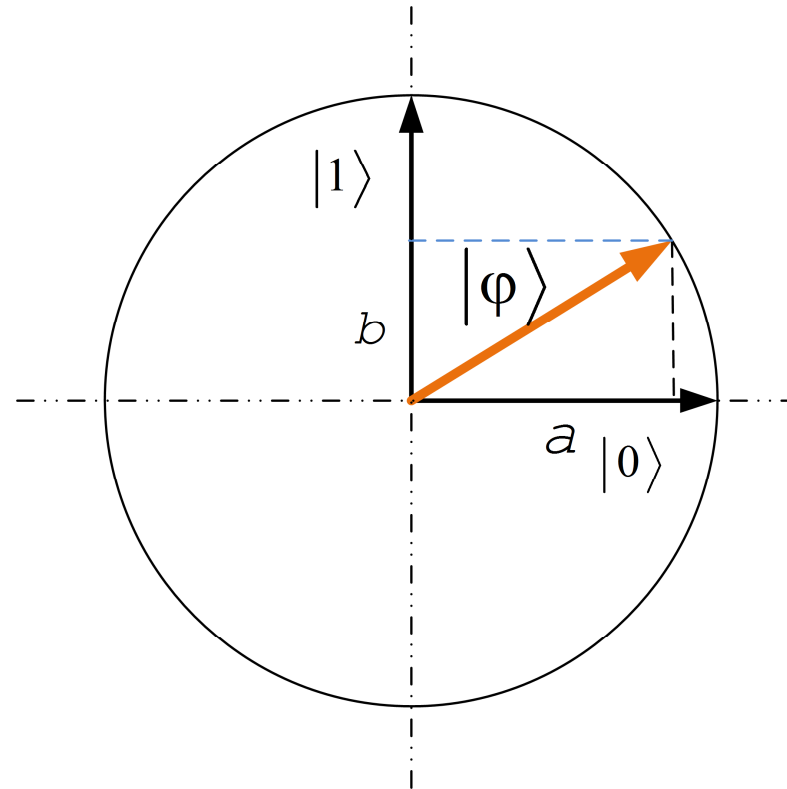

**Mire használható?**

**Mire használható?**

**Teleportálás**

# ÖSSZEFONÓDÁS

$$|\varphi\rangle = a|00\rangle + b|11\rangle$$

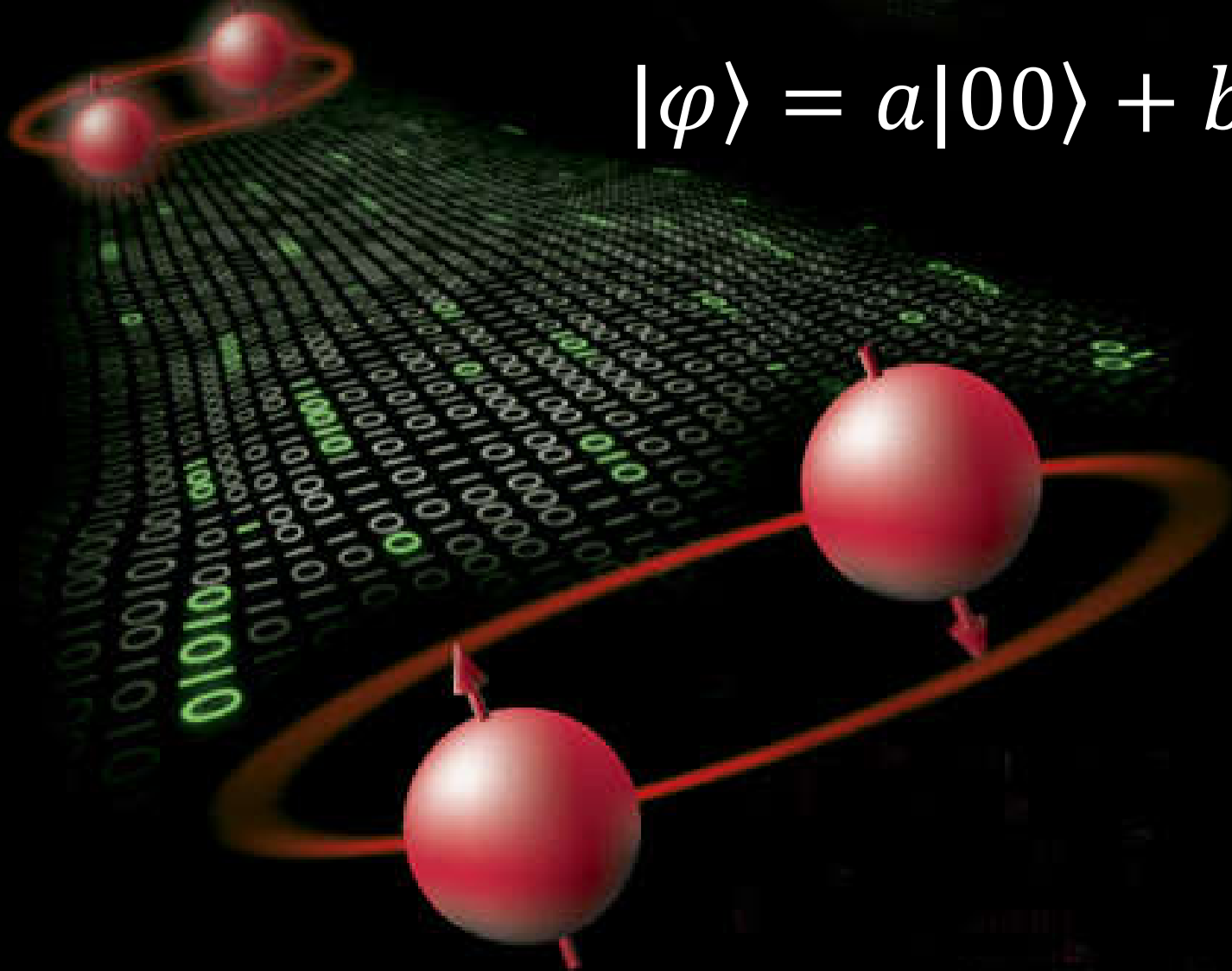

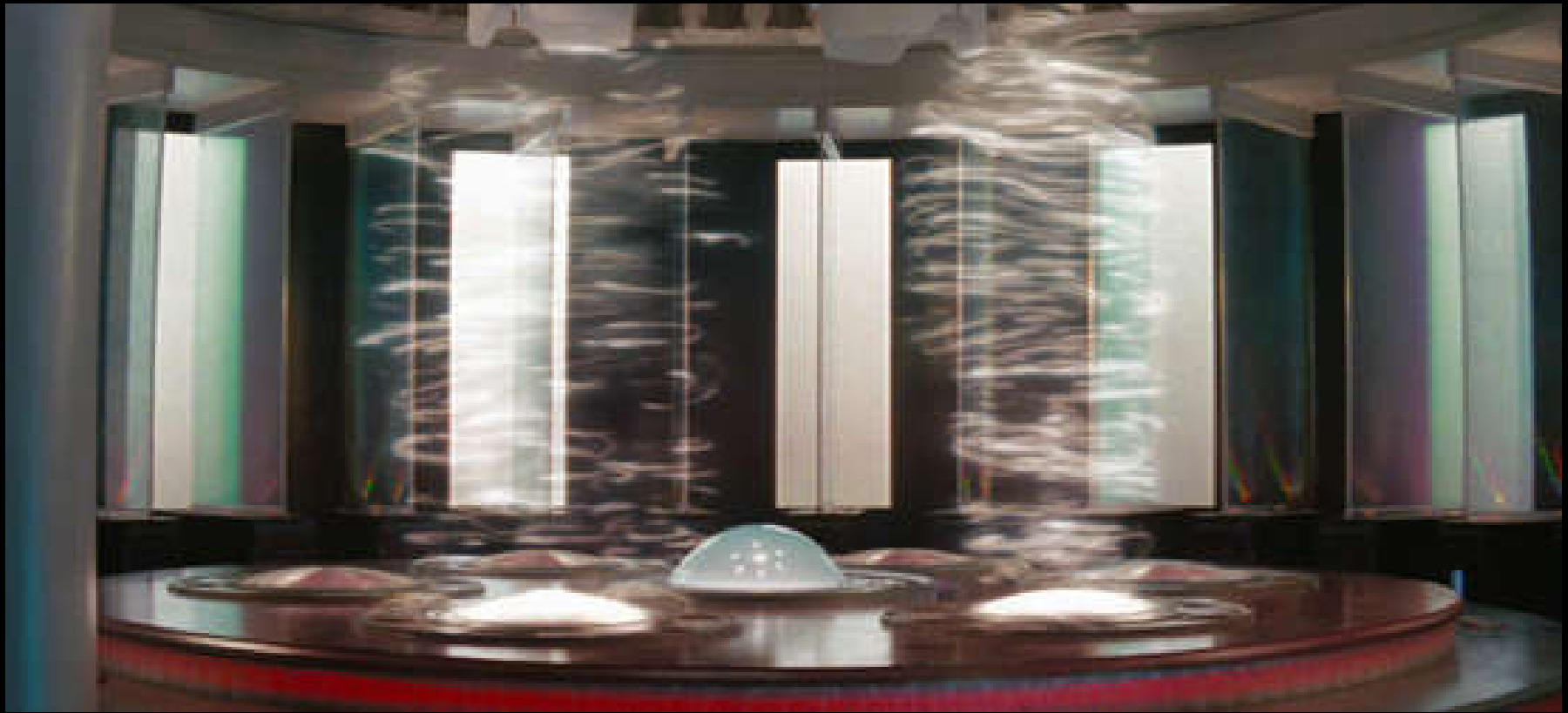



Afalfjd

Open Question

[Show me another »](#)

## Is teleportation allowed in table tennis or ping pong?

What if the opponent hits it really far back and I can't reach it and so I decided to shift/teleport into that location that I couldn't quickly reach and then return the ball? So is teleportation allowed?

3 days ago - 1 day left to answer.

[Report Abuse](#)

[Answer Question](#)

**Mire használható?**

**Feltörés**



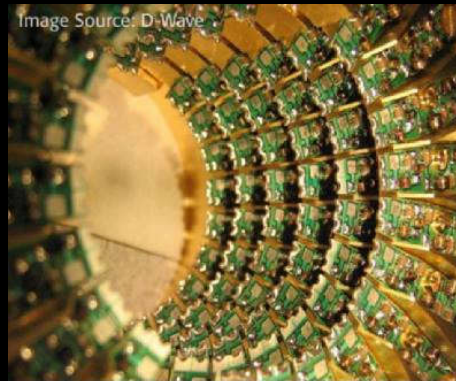

30 Qubit Computer  
**10 teraFLOPS**



30 Bit Computer  
**~0.5 megaFLOPS**

**Quantum computers perform  
2 million times faster**



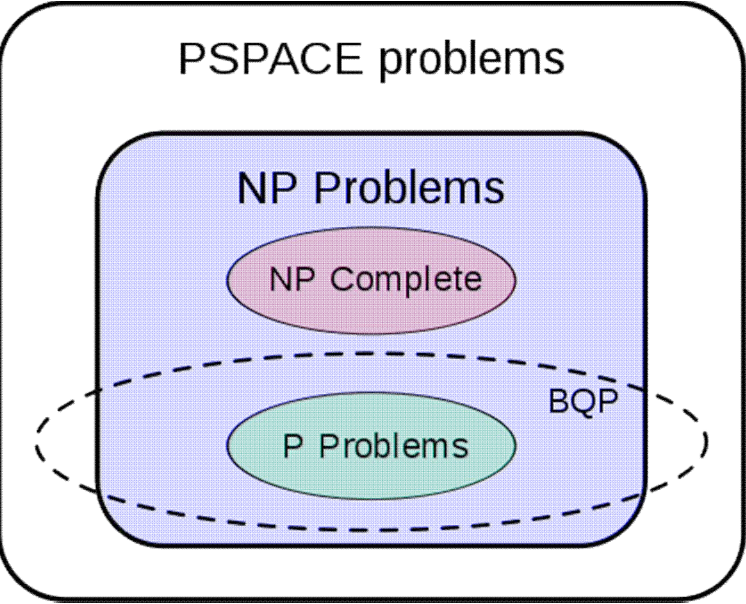

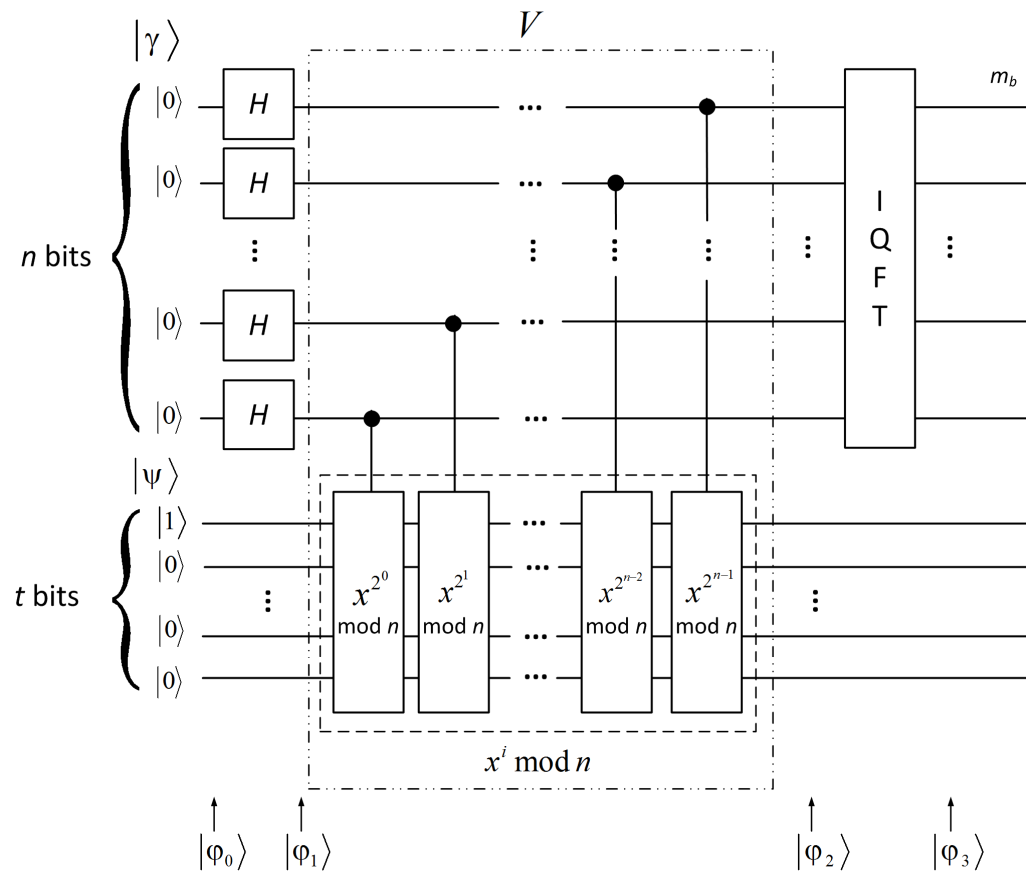

# SHOR-ALGORITHMUS

15

21

143

*Martín-López, Enrique et al. „Experimental realization of Shor's quantum factoring algorithm using qubit recycling”, Nature Photonics 6, 773–776, (2012)*

*Nanyang Xu, Jing Zhu, Dawei Lu, Xianyi Zhou, Xinhua Peng, and Jiangfeng Du, Quantum Factorization of 143 on a Dipolar-Coupling Nuclear Magnetic Resonance System, Phys. Rev. Lett. 108, 130501 (2012).*

# SHOR-ALGORITHMUS

15

21

143

56153

*Martín-López, Enrique et al. „Experimental realization of Shor's quantum factoring algorithm using qubit recycling”, Nature Photonics 6, 773–776, (2012)*

*Nanyang Xu, Jing Zhu, Dawei Lu, Xianyi Zhou, Xinhua Peng, and Jiangfeng Du, Quantum Factorization of 143 on a Dipolar-Coupling Nuclear Magnetic Resonance System, Phys. Rev. Lett. 108, 130501 (2012).*

*Nikesh S. Dattani and Nathaniel Bryans. "Quantum factorization of 56153 with only 4 qubits." arXiv:1411.6758 [quant-ph]*

**Mire használható?**

**Kvantum alapú kulcsszétosztás**

# Biztonságos kommunikáció

Szimmetrikus kulcsú titkosítás

Kulcsok megosztása

Kvantummechanika elvei alapján lehallgathatatlan



# A globális kvantum alapú kulcsszétosztás helyzete

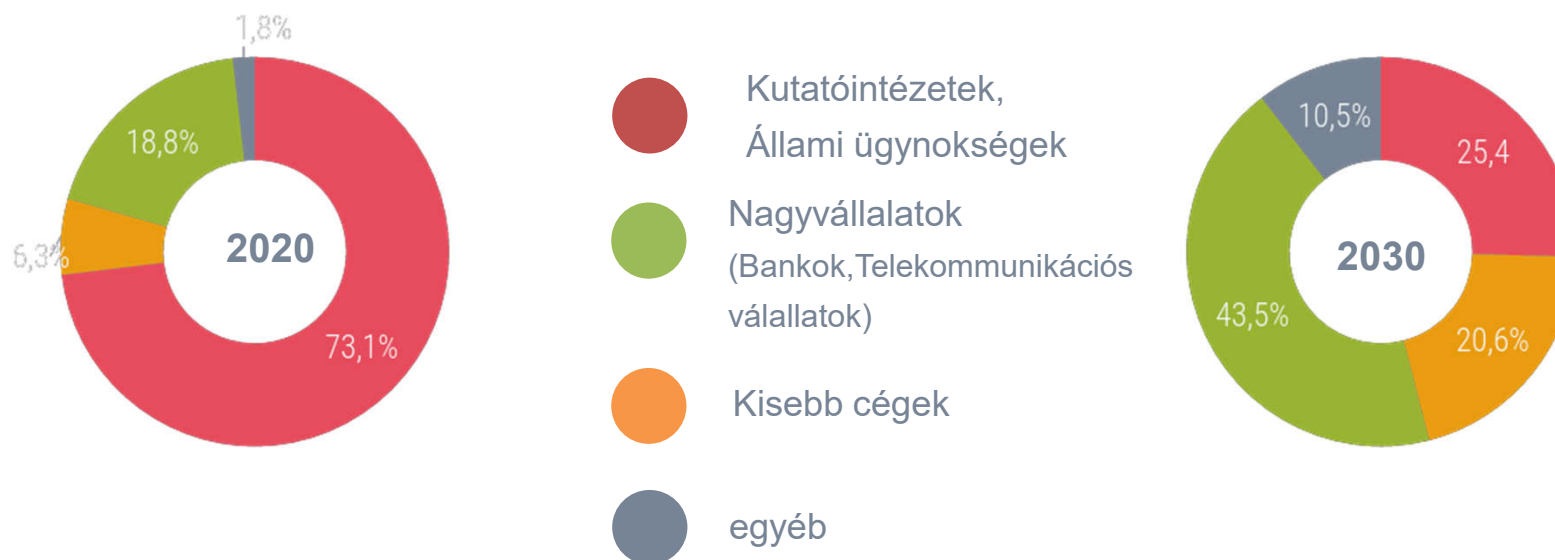

A piac várható nagysága 2024-re: 2 milliárd dollár

Source : [http://www.strategyr.com/MarketResearch/Quantum\\_Cryptography\\_Market\\_Trends.asp](http://www.strategyr.com/MarketResearch/Quantum_Cryptography_Market_Trends.asp)



# Gyors technológiai fejlődés

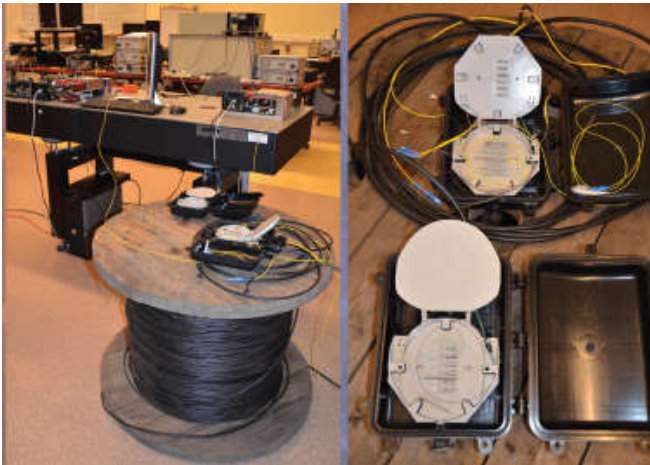

Optikai kábel	
1989/91	30 cm
1993	1100 m
1995	23 km
2007	67 km
2016	404 km

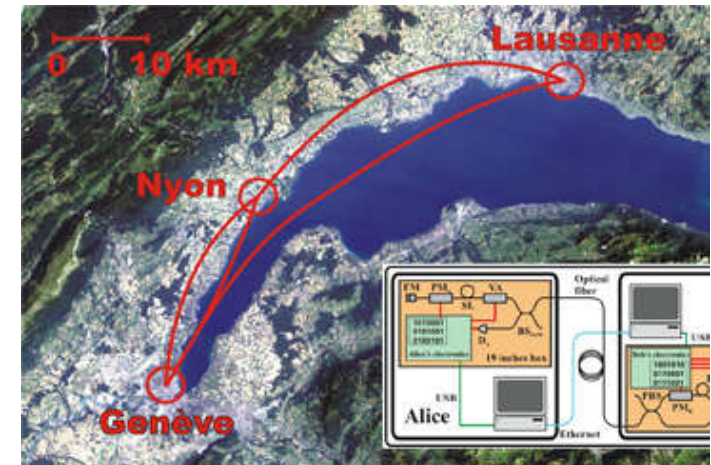

Szabad légkör	
1996	75 m
1998	1 km
2001	2 km
2002	10 km
2007	144 km

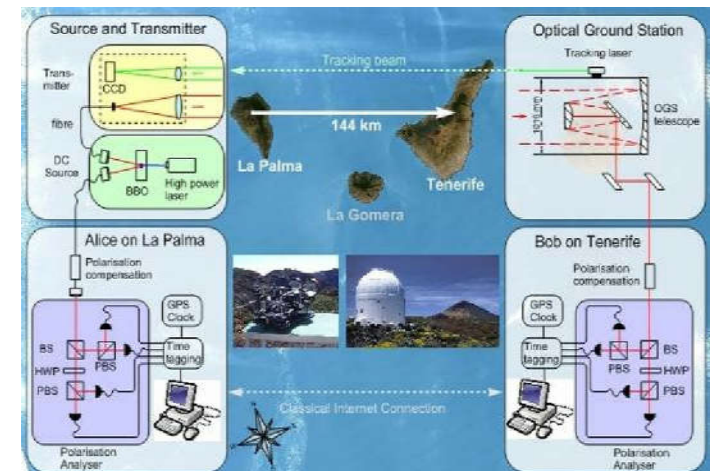

# Műholdas csatorna előnyei

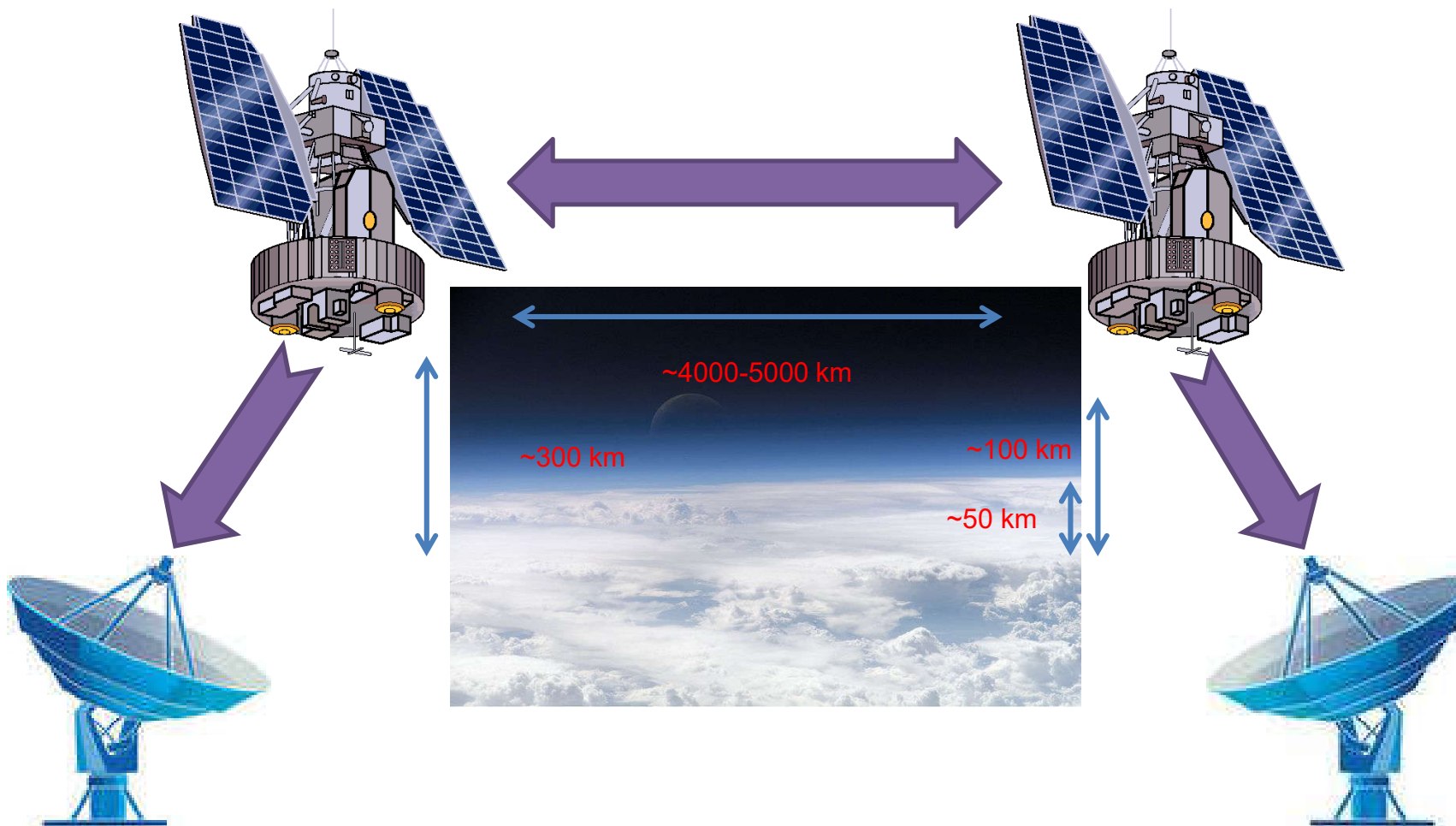

Ábra: Galambos Máté: Miért pont műhold? (HTE Távközlési Klub, 2017. május 25.)

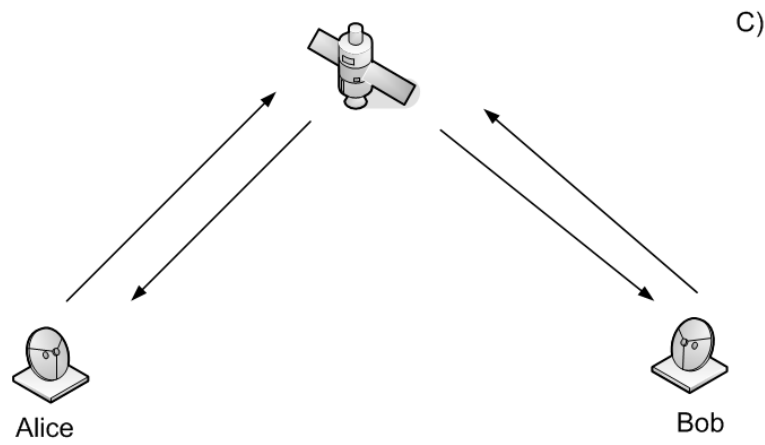
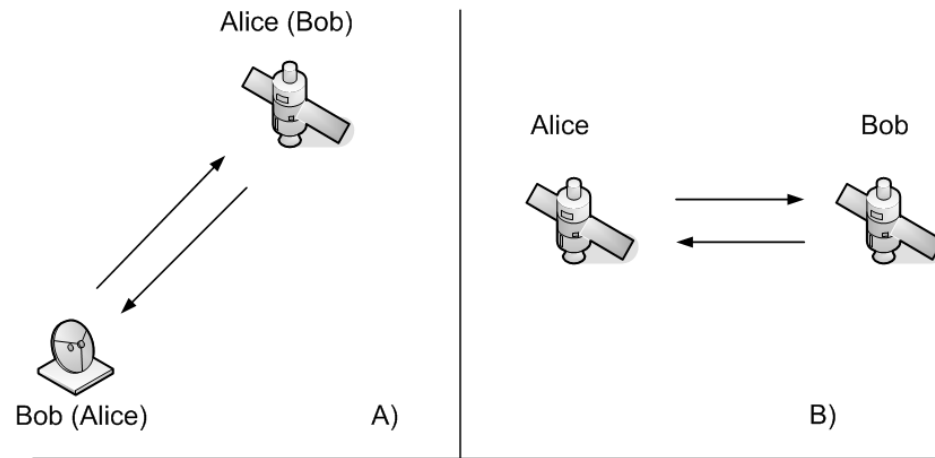

# Műholdas kvantumkommunikációs csatorna

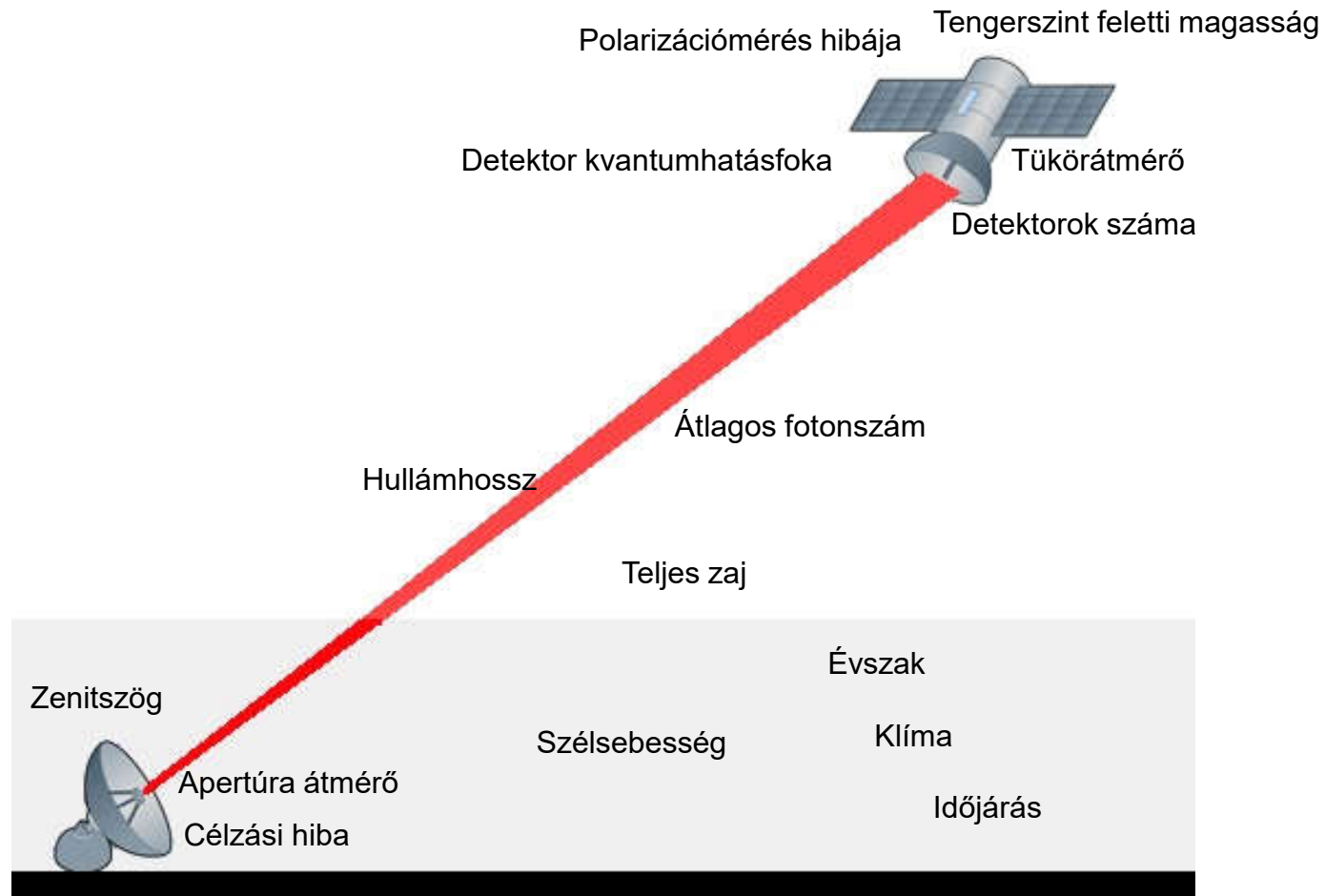

[Space.com](#) > [Tech](#)

# China Launches Pioneering 'Hack-Proof' Quantum-Communications Satellite

By Mike Wall, Space.com Senior Writer | August 16, 2016 06:13pm ET

 385

 54

 19

 37

 1388

MORE ▾



China launched the first-ever quantum-communication satellite, known as QUESS, atop a Long March-2D rocket from the Jiuquan Satellite Launch Center on Aug. 15, 2016 (Aug. 15 local time).

Credit: Xinhua/Jin Liwang

<http://www.space.com/33760-china-launches-quantum-communications-satellite.html>

TUDOMÁNY ÉS TECHNIKA

# Ezért örült nagy dolog a kínaiak „kvantumműholdja”

MTI

2016. augusztus 16., kedd 21:47, frissítve: kedd 22:11

A kvantumkommunikáció olyan megoldásokat kínál, amelyek rendkívül hasznosak lehetnek a mindennapokban – mondta az MTI-nek Bacsárdi László, az NYME SKK Informatikai és Gazdasági Intézetének igazgatója kedden, nem sokkal azután, hogy Kína sikeresen felbocsátotta a világ első kvantumkommunikációs műholdját az északnyugat-kínai csiucsüani űrközpontból.

# 'Much better than expected': Chinese 'hack-proof' quantum communication satellite put into service

Published time: 19 Jan, 2017 04:43

[Get short URL](#)



Beijing Aerospace Control Center. © Ju Zhenhua / Xinhua / Global Look Press via ZUMA Press



The world's first quantum communication satellite is now officially operational following months of in-orbit testing, the Chinese Academy of Sciences (CAS) announced, saying that performance of the device is "much better" than was initially expected.

<https://www.rt.com/news/374167-china-quantum-satellite-operational/>

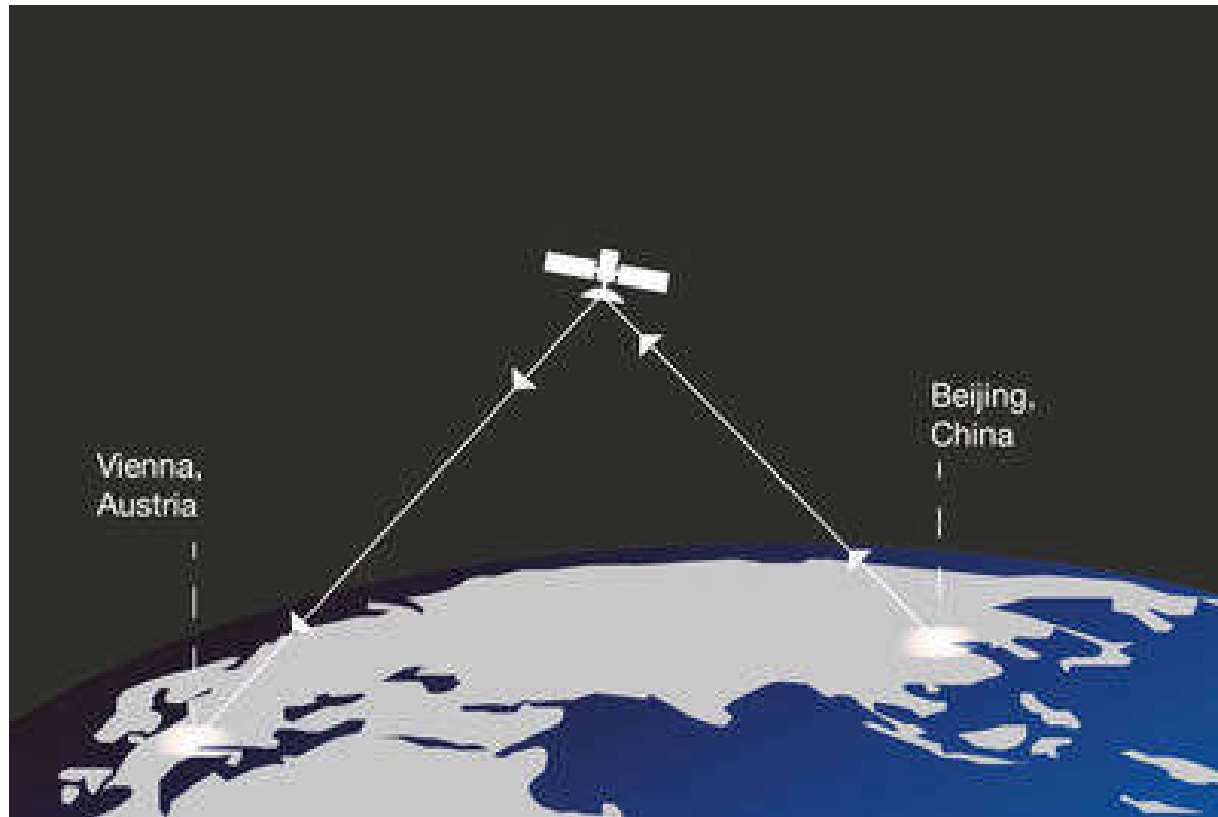



# Quantum Manifesto

A New Era of Technology

May 2016

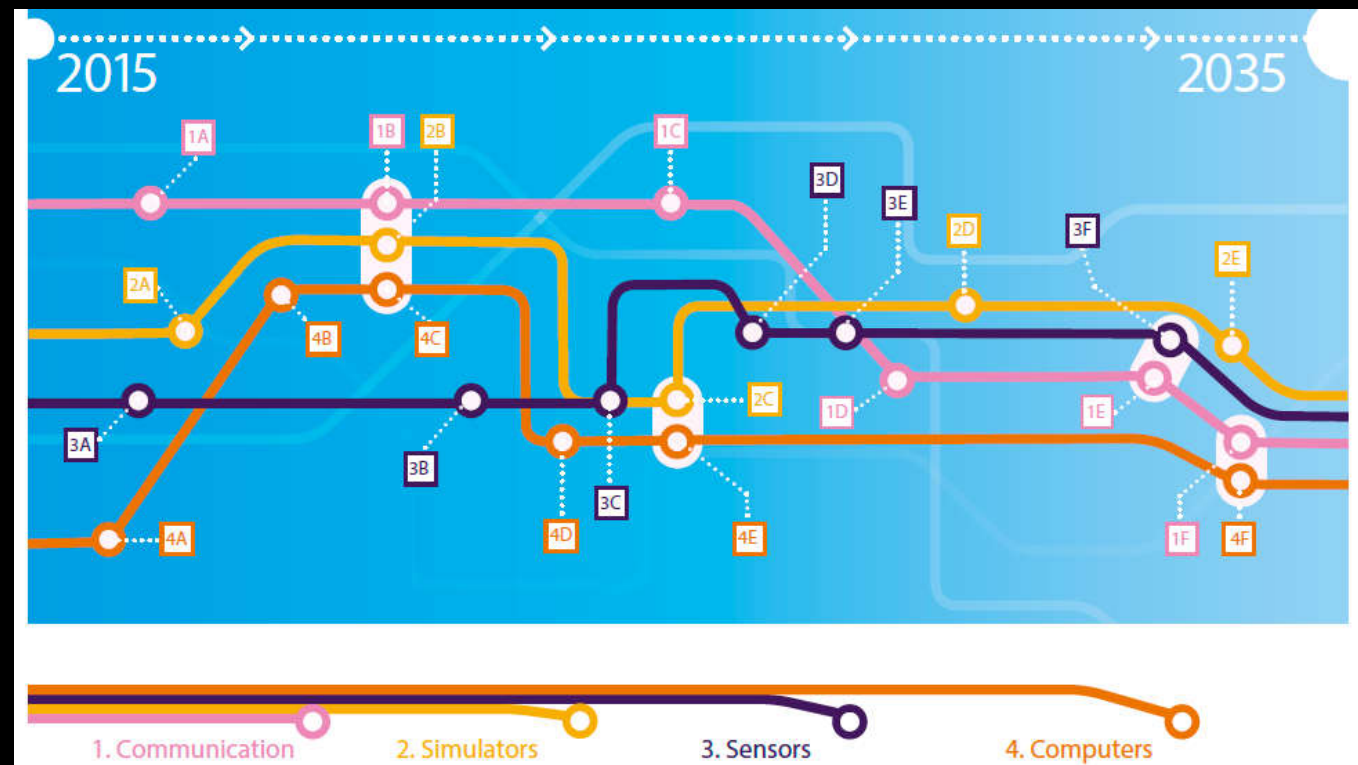



# QTSPACE

## QUANTUM TECHNOLOGIES IN SPACE

The scientific and technological legacy of the 20th century includes milestones such as **quantum mechanics** and **pioneering space missions**. Both endeavours have opened new avenues for the furthering of our understanding of Nature, and are true landmarks of modern science. Quantum theory and space science form building blocks of a powerful research framework for exploring the **boundaries of modern physics** through the unique working conditions offered by experimental tests performed in space.

Long free-fall times enable **high-precision tests** of general relativity and tests of the **equivalence principle** for quantum systems.

Harnessing microgravity, high vacuum and low temperature of deep space promises allowing the study of **deviations from standard quantum theory** for high-mass test particles. Space-based experiments of metrology and sensing will push the **precision of clocks**, mass detectors and transducers towards the engineering of **novel quantum technologies**.

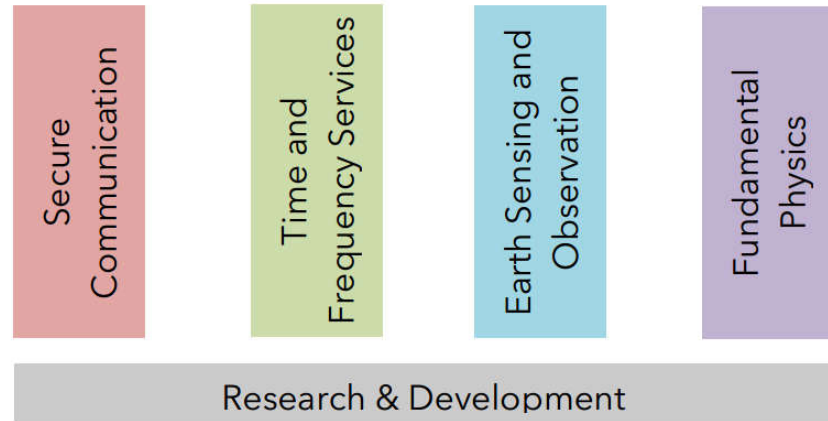



munich

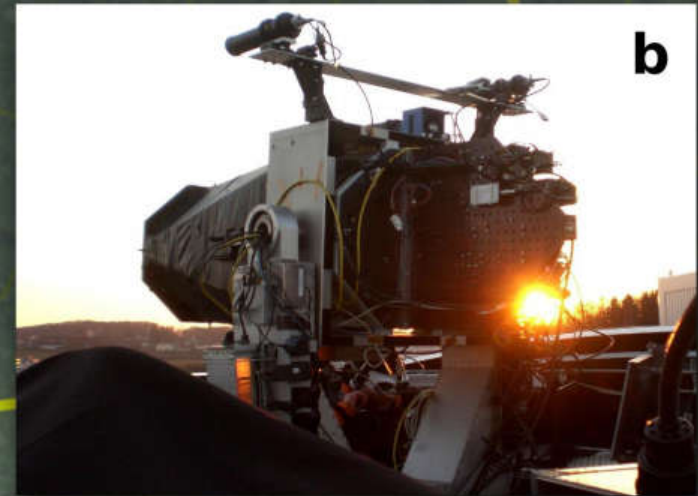
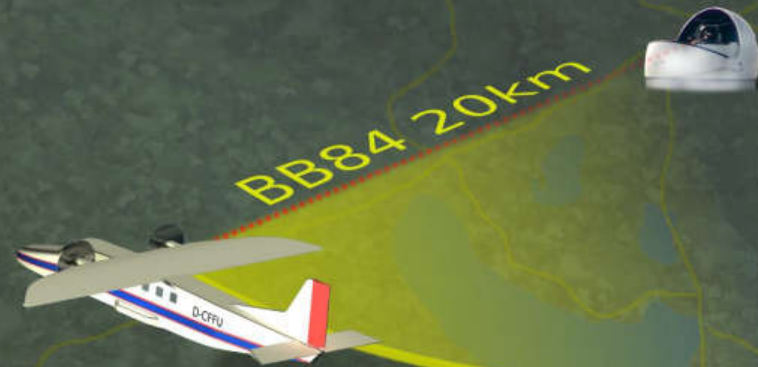



## Metropolitan Quantum Communication

Using coherent quantum communication to enhance the security of intra-city cryptography. Coherent Quantum Key Distribution Our quantum key distribution systems are based on coherent telecommunication technology. Quantum states are distributed with state-of-the-art rates of 10 Gbaud via an optical fiber link,...

## Satellite Quantum Communication

We use quantum-enhanced satellites to provide quantum communication on a global scale. Quantum Communication on a global scale Current quantum communication technologies are limited by a fixed amount of tolerable loss for the quantum signals. In fibers, this loss scales...

## Quantum Random Number Generation

Harnessing the power of quantum mechanics to generate true and unique, high-speed random numbers. Quantum random numbers from the vacuum While a coin toss or the casting of a die may seem random, short-term behaviour is very predictable when for example...

# Quantum Encryption and Science Satellite (QEYSSat)



Principal Investigator Professor Thomas Jennewein

Institute for Quantum Computing (IQC) researcher Thomas Jennewein is pioneering new applications for quantum technologies, in particular quantum communications networks in space.



## Recent media

04/27/17 - [Press release](#) from Innovation, Science and Economic Development Canada

02/02/17 - [Wired article](#) by Sophia Chen

12/22/16 - ["We've got photons!"](#)

12/21/16 - [Researchers successfully demonstrate prototype for space-based quantum-secured communication](#)

12/20/16 - [Globe and Mail article](#) by Ivan Semeniuk

09/12/16 - [IQC researchers successfully conduct airborne demonstration of quantum key distribution](#)

05/05/16 - [IQC researcher awarded CSA grant to demonstrate quantum communications technologies aboard student space mission](#)

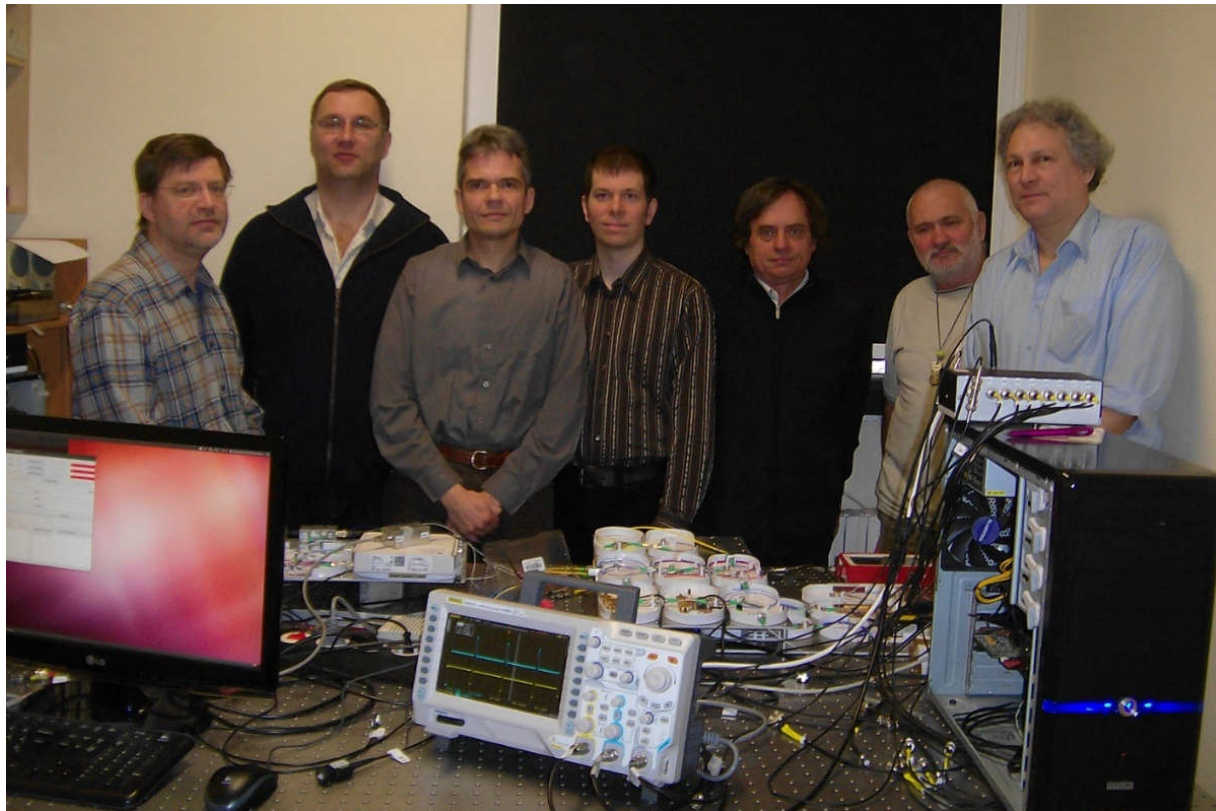



# Qrypt Solutions

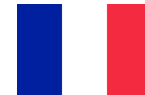

# MEGHÍVÓ

sajtótájékoztatóra

## PROGRAM

**10.00**  
**Köszöntő**

**Dr. Lovász László**  
Magyar Tudományos Akadémia Elnöke

**Dr. Pálinkás József**  
a Nemzeti Kutatási, Fejlesztési,  
és Innovációs Hivatal elnöke

**10.10**  
**A program szakmai ismertetése**

**Dr. Domokos Péter**  
HunQuTech konzorcium vezetője,  
MTA Wigner Fizikai Kutatóközpont

**10.40 Kérdések-válaszok**

**11:15 Büfé**

A tájékoztató nyilvános, sajtóregisztráció:  
vidak.rozsa@wigner.mta.hu címen.

A kvantummechanika elvein alapuló információkezeléshez és számításokhoz épült kvantumbit-eszközöket a HunQuTech konzorcium. A „Kvantumbitek előállítása, megosztása és kvantuminformációs hálózatok fejlesztése” című projektet a Nemzeti Kutatási Fejlesztési és Innovációs Alap négy éven keresztül 3.5 milliárd forinttal támogatja a Nemzeti Kiválósági Program keretében.

A **HunQuTech** konzorcium tagjai:  
a **BME**, **ELTE**, **MTA EK**, **MTA WIGNER FK**, **BHE**,  
**Ericson Magyarország**, **FEMTONICS**, és a **NOKIA BELL**  
tisztelettel meghívják Önt

## SAJTÓTÁJÉKOZTATÓJUKRA

az MTA Székház Felolvasótermébe  
**2018. február 7-én, szerdán 10.00 órára.**



NEMZETI KUTATÁSI, FEJLESZTÉSI  
ÉS INNOVÁCIÓS HIVATAL



NOKIA Bell Labs





facebook.com/kvantumbit



$$\frac{1}{\sqrt{2}}|\text{bacsardi@hit.bme.hu}\rangle + \frac{1}{\sqrt{2}}|\text{bacsardi@inf.uni-sopron.hu}\rangle$$